

Let us learn the Hadeeth

Vocabulary of Saheehul-Bukhaaree



My Colouring Book

Book 7

WRITTEN BY

ABOO IBRAAHEEM HAROON BIN SAAJIDUR-RAHMAAN

أبو إبراهيم هارون بن ساجد الرحمان

Helping your child

Tips



The activities in this book should be enjoyed by your child.

Try to find a quiet place to work.



Always give your child lots of encouragement and praise.



My name is: _____

1) Whip

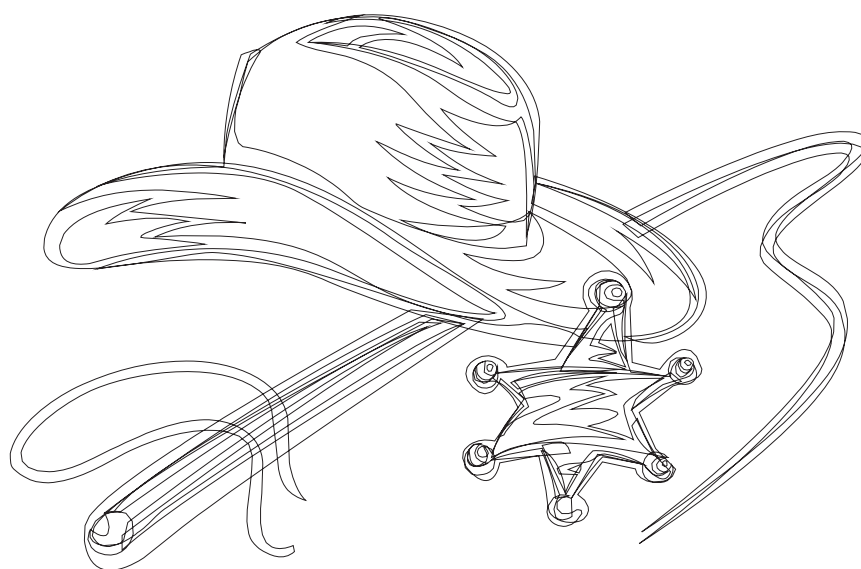

سَوَاطِيفُ

2) (Money) Bag



م
ب
ه
ص

3) Night

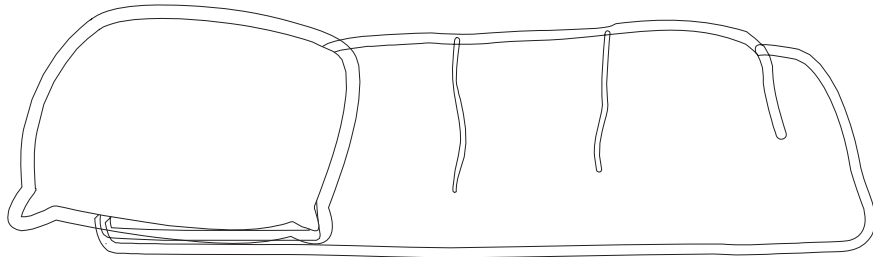
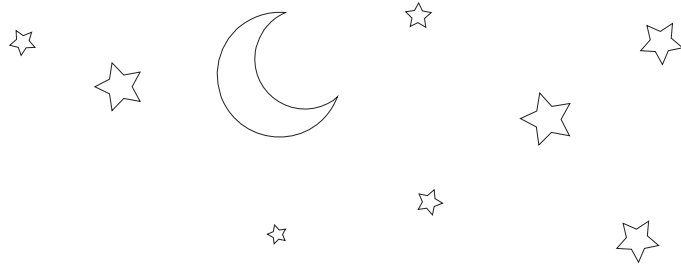

لَیْلٍ

4) Sun

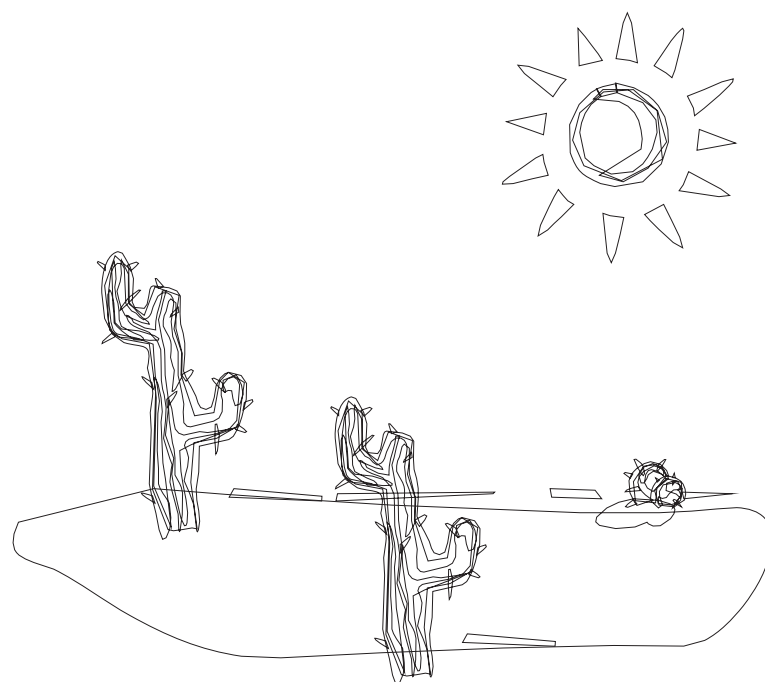

شَمْس

Exercise 1:

Draw a line to join the picture with the Arabic word.



لَيْلٌ

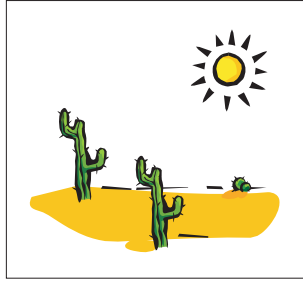

سَوَاطٍ

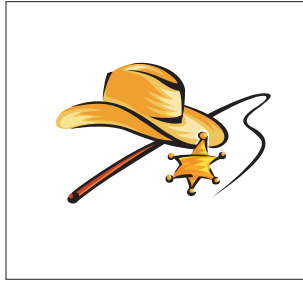

شَمْسٌ



صِرَةٌ

5) Journey

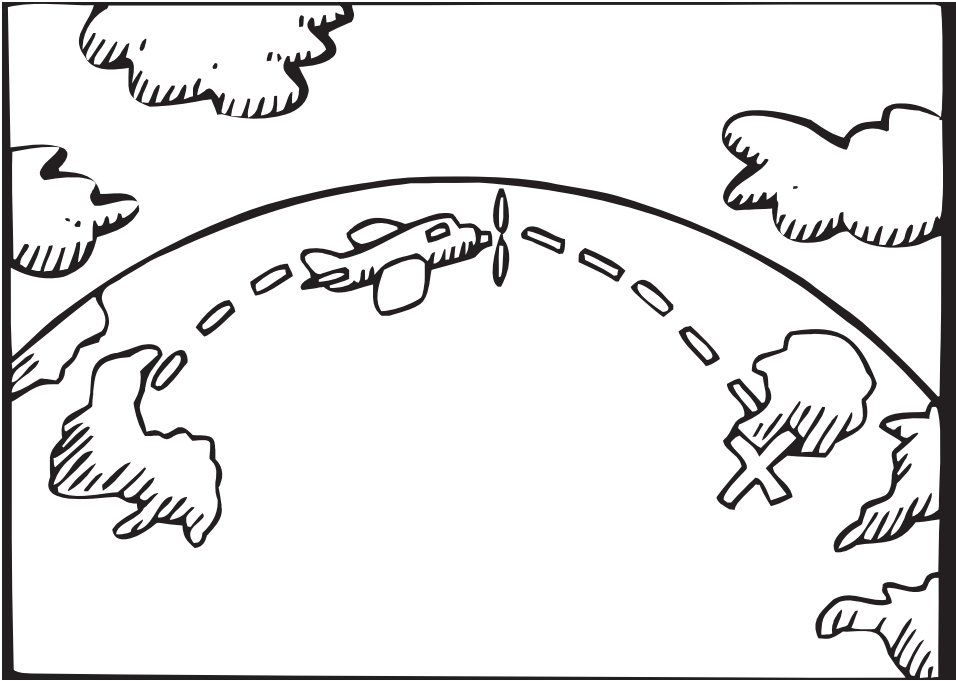

سَفَرٌ

6) Thirst

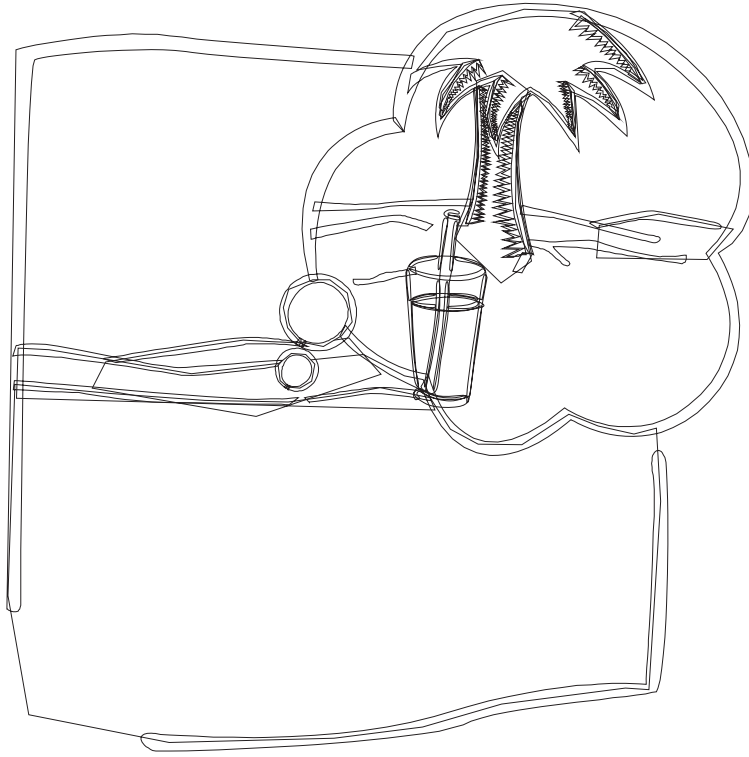

عَطَشٌ

7) Grass

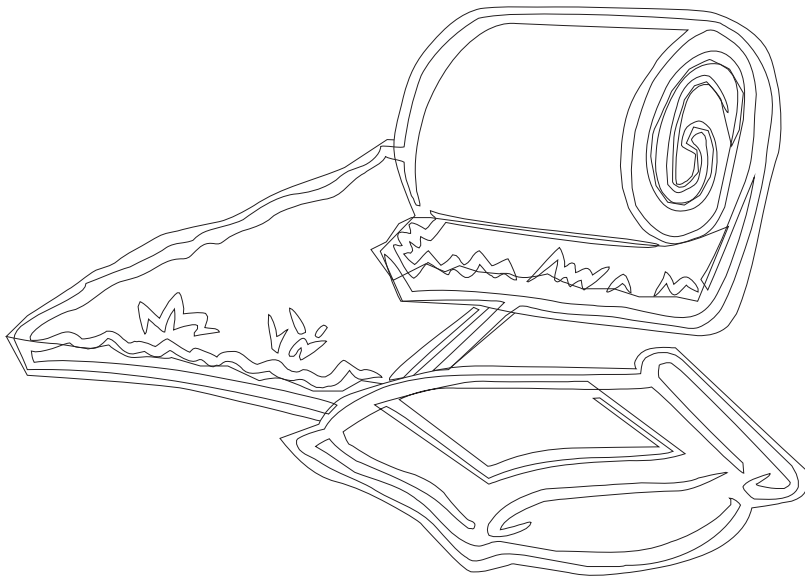

عُشْبٌ

8) River

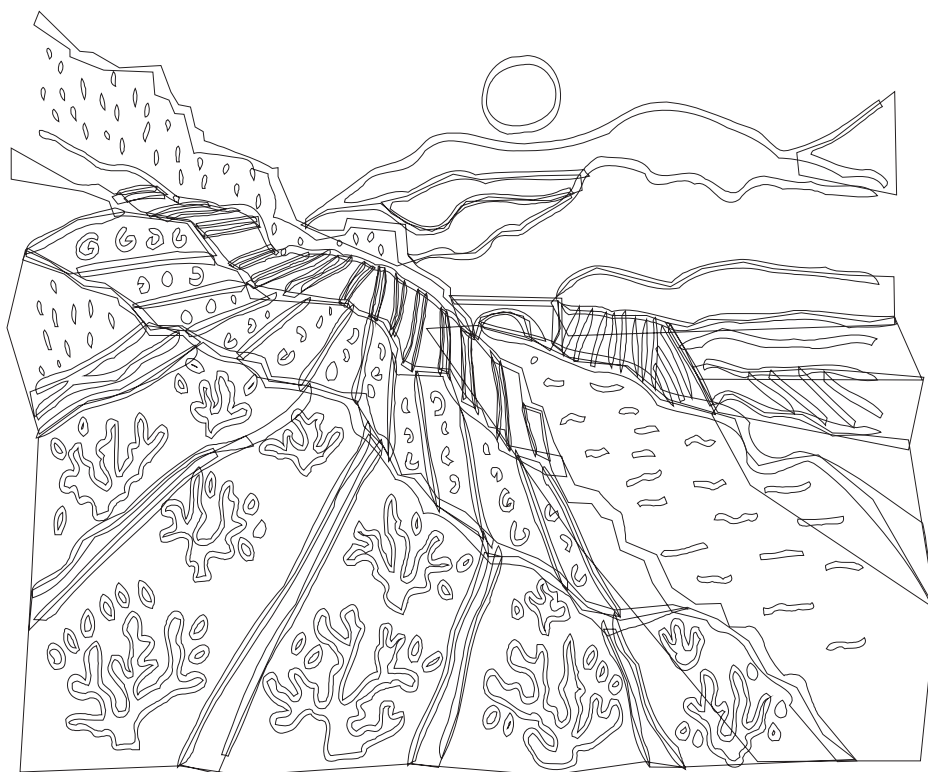

نهر

Exercise 2:

Draw a line to join the picture with the Arabic word.



عَطَشٌ

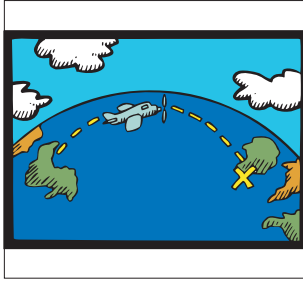

نَهْرٌ



سَفَرٌ



عُشْبٌ

9) Raisins (Raisins are dried grapes.)



زَيْب

10) Silver

(A soft white metal. e.g silver dinner set.)

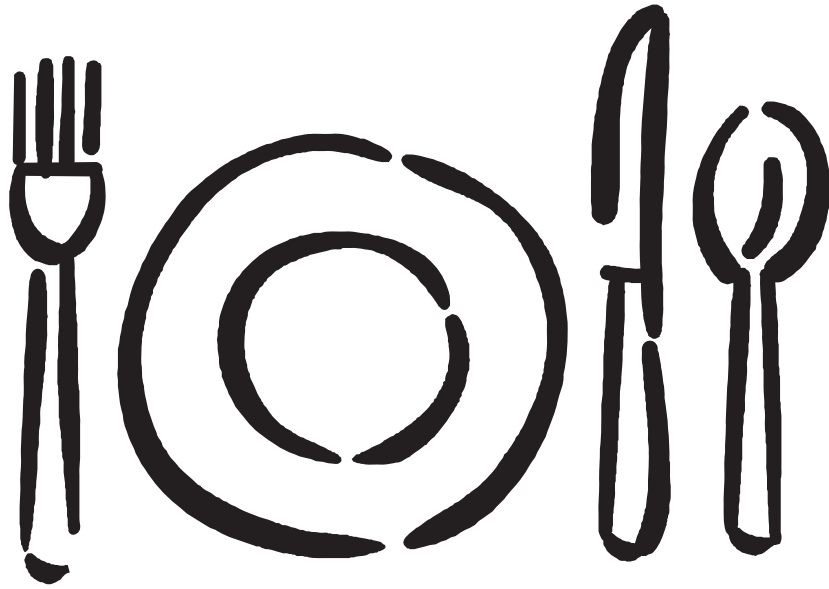

فضة

11) Cushion

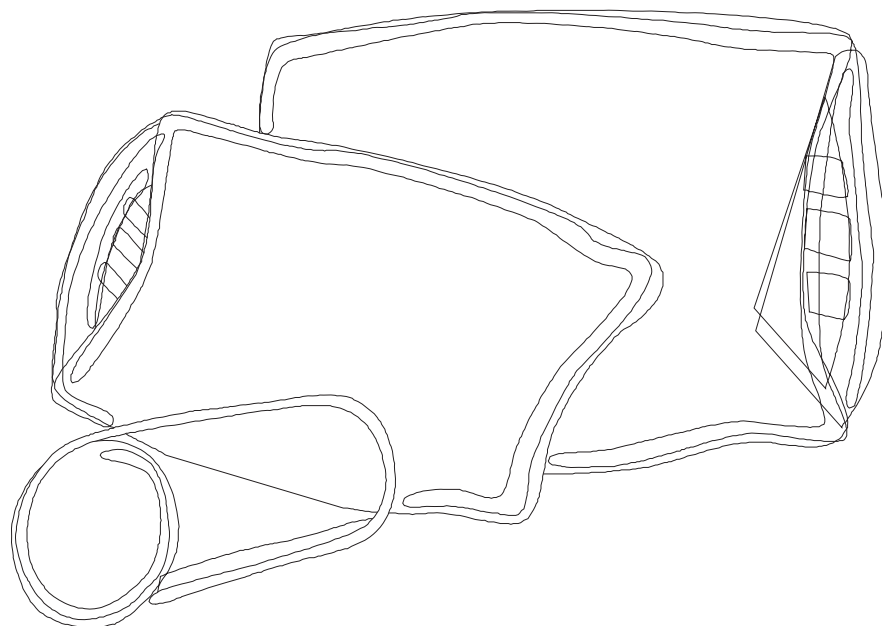

وسَادَةٌ

12) Ear

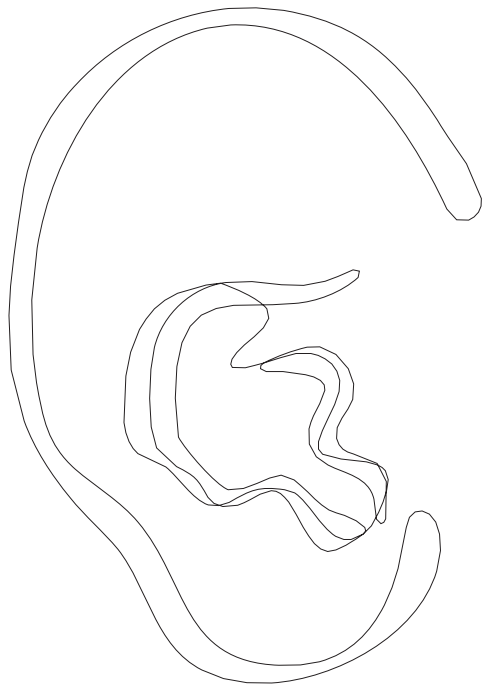

أذن

Exercise 3:

Draw a line to join the picture with the Arabic word.



فِضَّةٌ



زَيْبٌ



أُذُنٌ

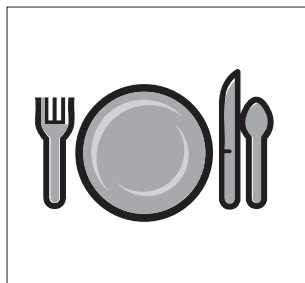

وَسَادَةٌ

13) Trouser

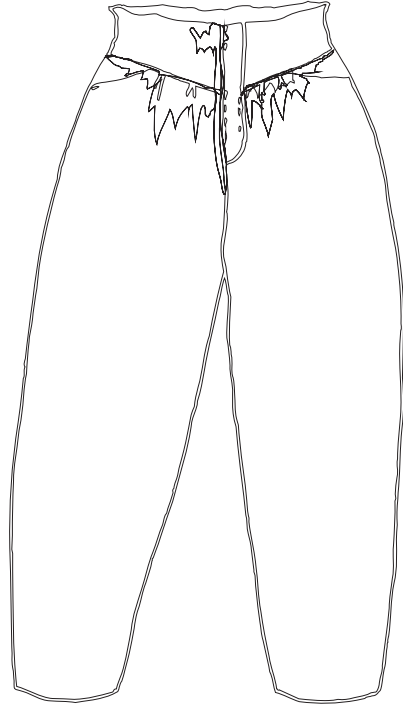

سِرْوَال

14) Brick

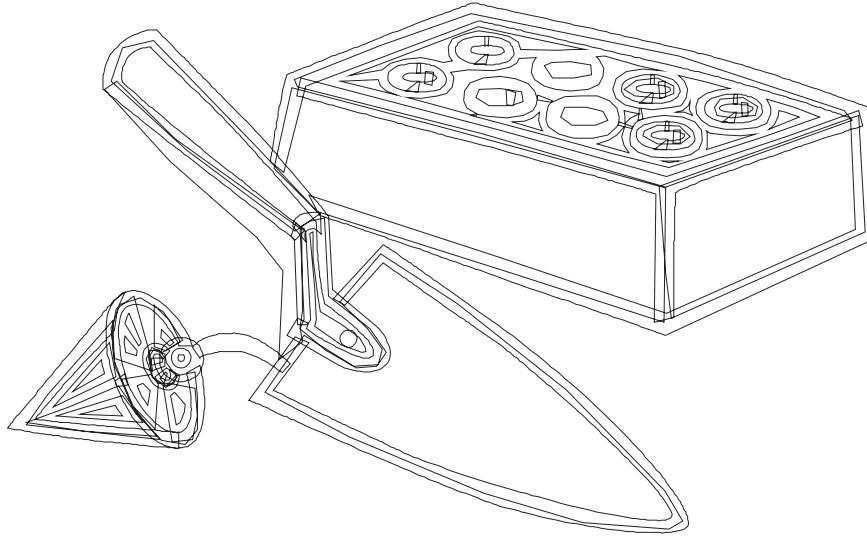

كِبْرِي

15) Eye

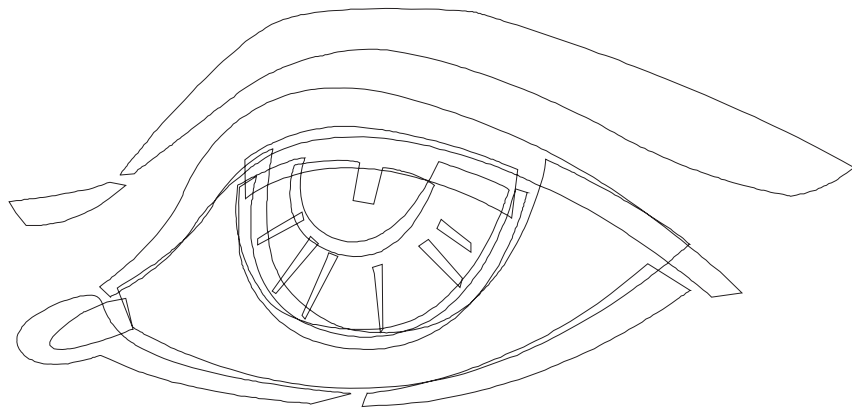

عَيْنٌ

16) Fort

(A strong or fortified place for protection against the enemy.)

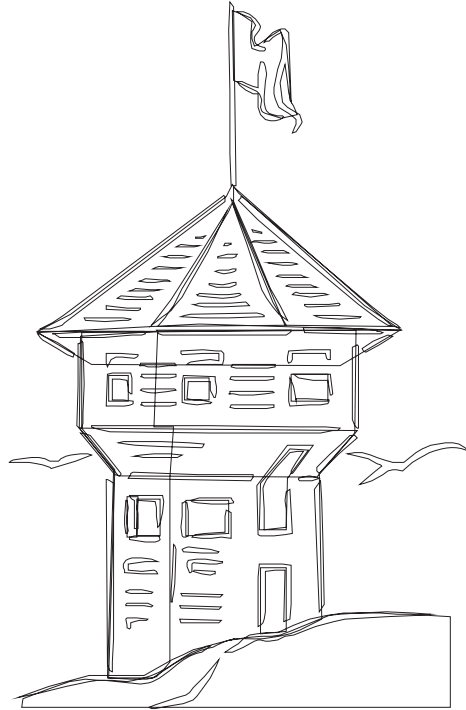

حصن

Exercise 4

Draw a line to join the picture with the Arabic word.

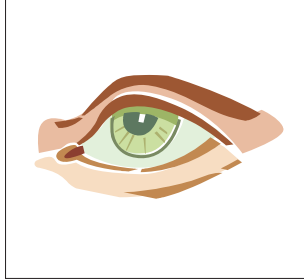

لَبِنٌ



عَيْنٌ

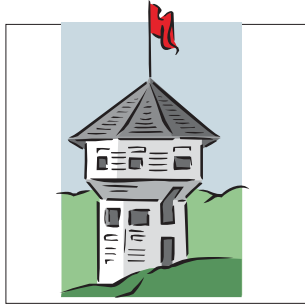

سِرْوَالٌ

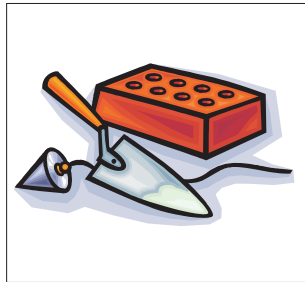

حَصْنٌ

Let us learn the Hadeeth

We want you and your children to enjoy learning with us. If you have any comments, please contact us. Your views mean a lot to us.

Email address: haroon@arabicfirst.co.uk

ISLAMIC WEBSITES:

KNOWLEDGE BASE

salafipublications.com
troid.org
bakkah.net
fatwaislam.com
masjiduthaymeen.org
al-athariyyah.com
sunnahpublishing.net
therighteouspath.com

DISCUSSION

salafitalk.net

SCHOLARS

albani.co.uk
binbaz.co.uk
binuthaymin.co.uk
fawzan.co.uk
rabee.co.uk
muqbil.co.uk
ubayd.co.uk

REFERENCE

thenoblequran.com
sahihalbukhari.com
sahihmuslim.com

ARABIC

binbaz.org.sa
binothaimeen.com
rabee.net
sahab.net

AUDIO

salafiaudio.com
salaficast.net
troid audio

KIDS

arabicfirst.co.uk
islam4kids.com

ONLINE STORES

salafibookstore.com
troid.org