

Colouring Book 3

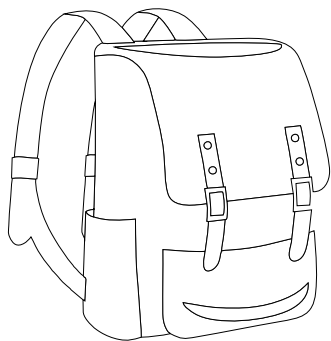

مَدْرَسَةٌ

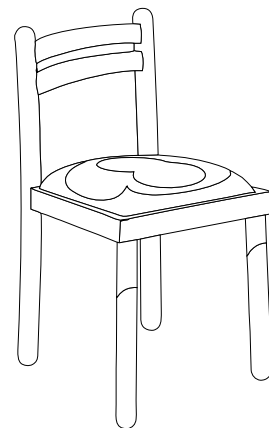

School

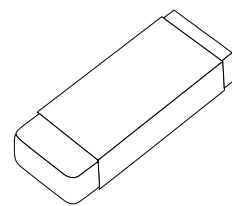
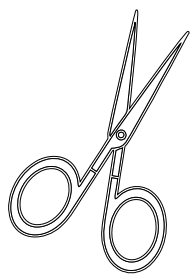
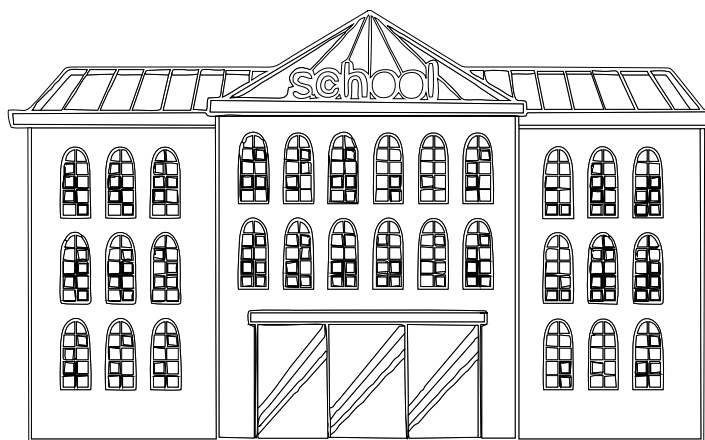

Written by

Abū Ibrāhēm Hārūn Bin Sājidur-Rahmān

أَبُو إِبْرَاهِيمَ هَارُونَ بْنِ سَاجِدِ الرَّحْمَنِ

مَدْرَسَةٌ

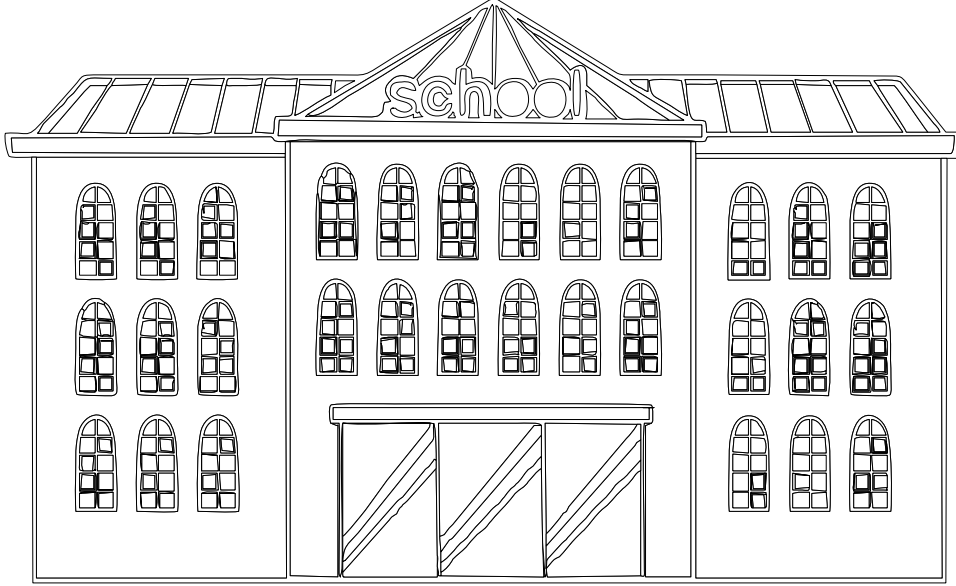

School

مُدِيرٌ

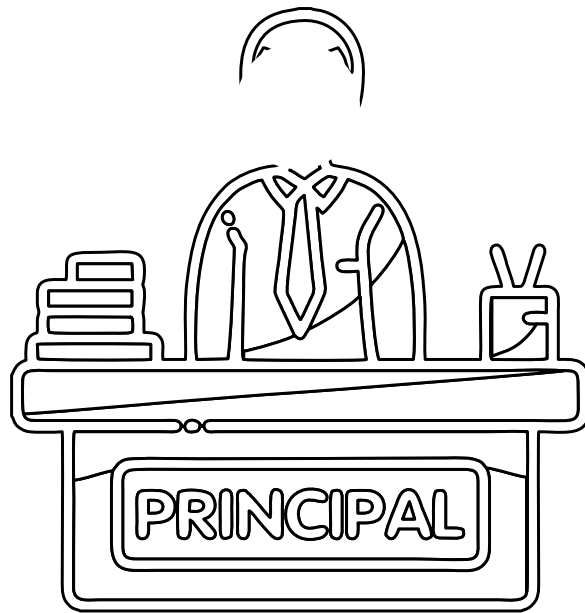

Principal (head teacher)

مُدَرِّسٌ

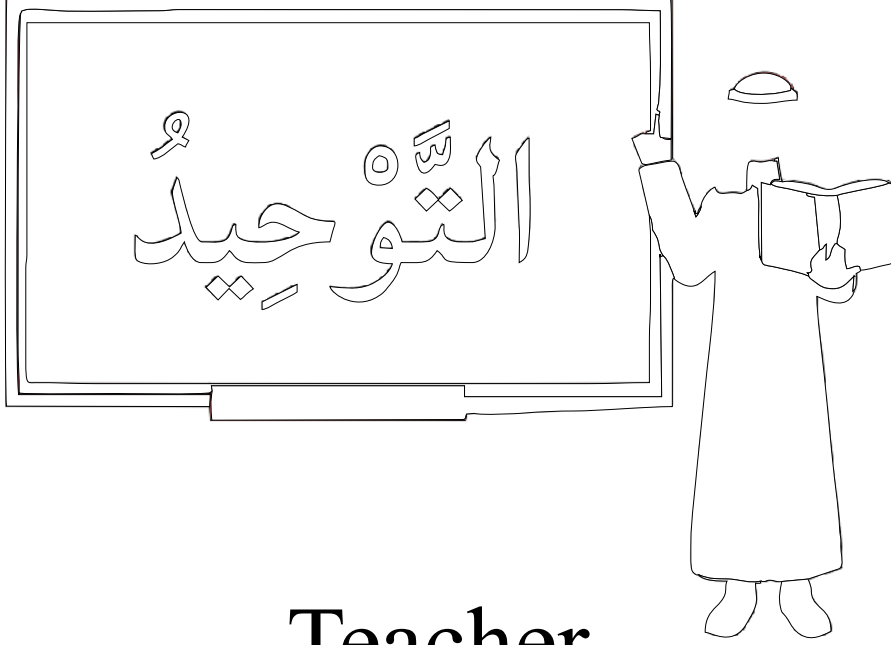

Teacher

طَالِبٌ



Student

سَبُورَةٌ

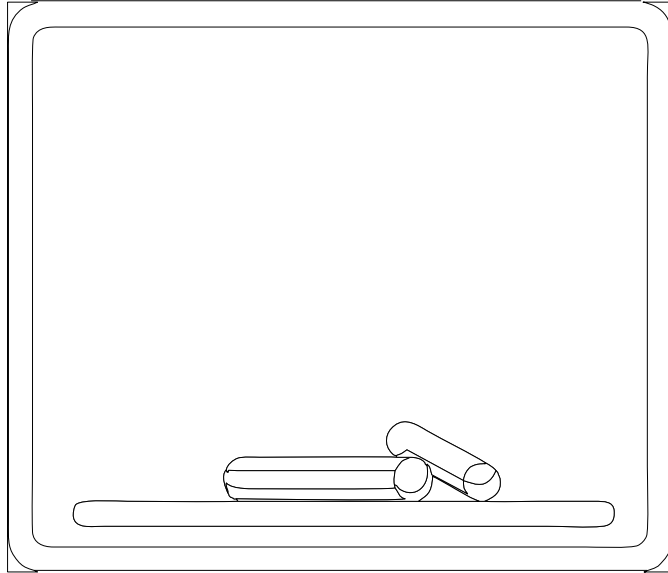

Board

حَقِيْبَةٌ

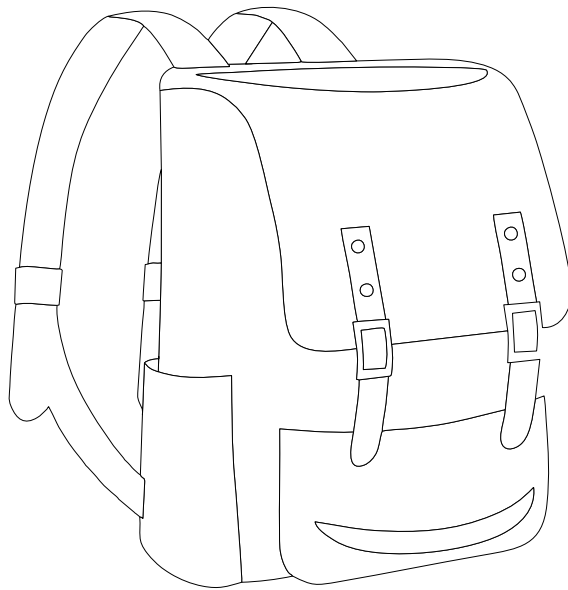

Bag

كُرْسِي

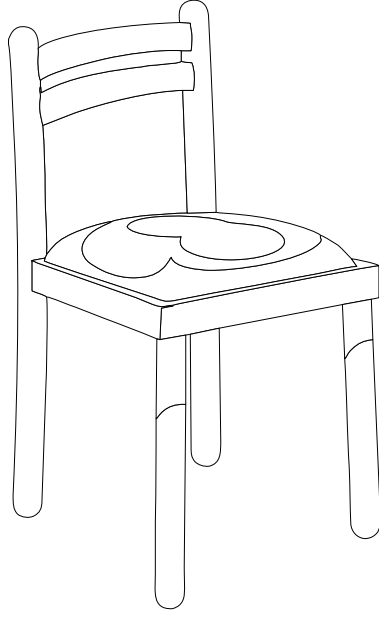

Chair

مَكْتَب

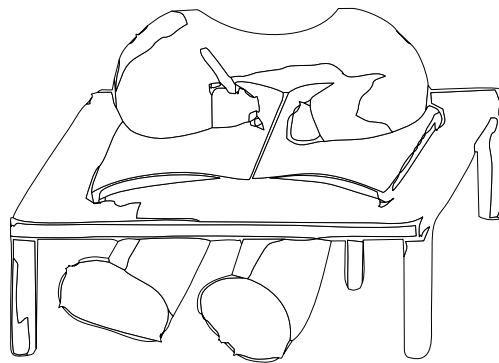
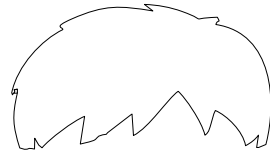

Desk

قَلَمٌ

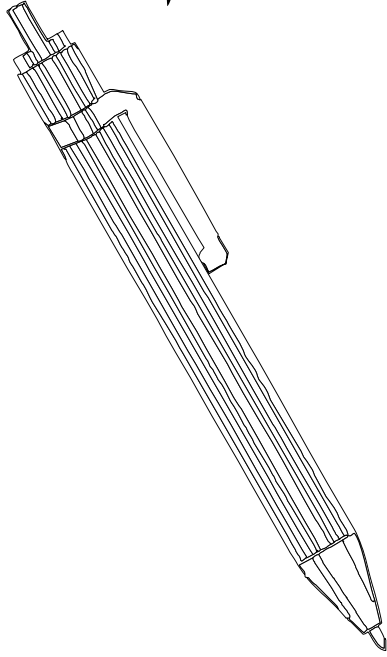

Pen

مِسْطَرَةٌ

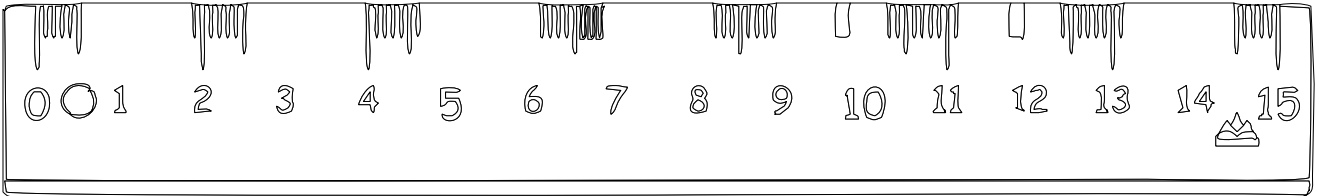

Ruler

مِقْصٌ

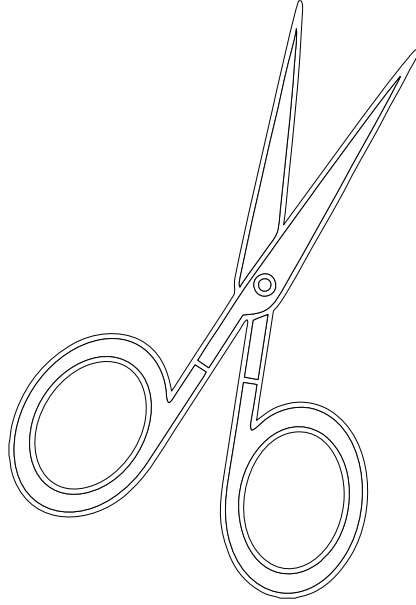

Scissors

مِمْحَاةٌ

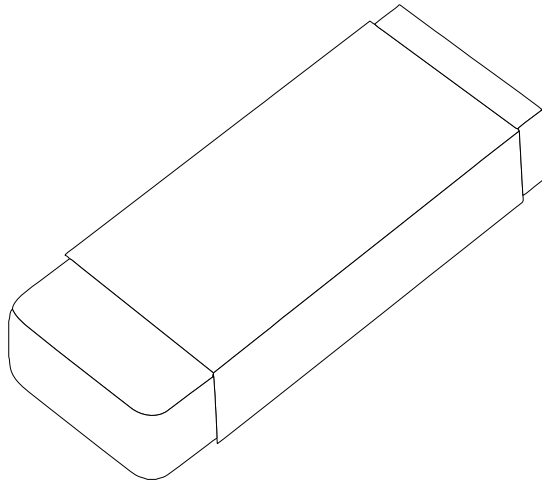

Rubber

مَكْتَبَةٌ



Library

مَلْعَبٌ

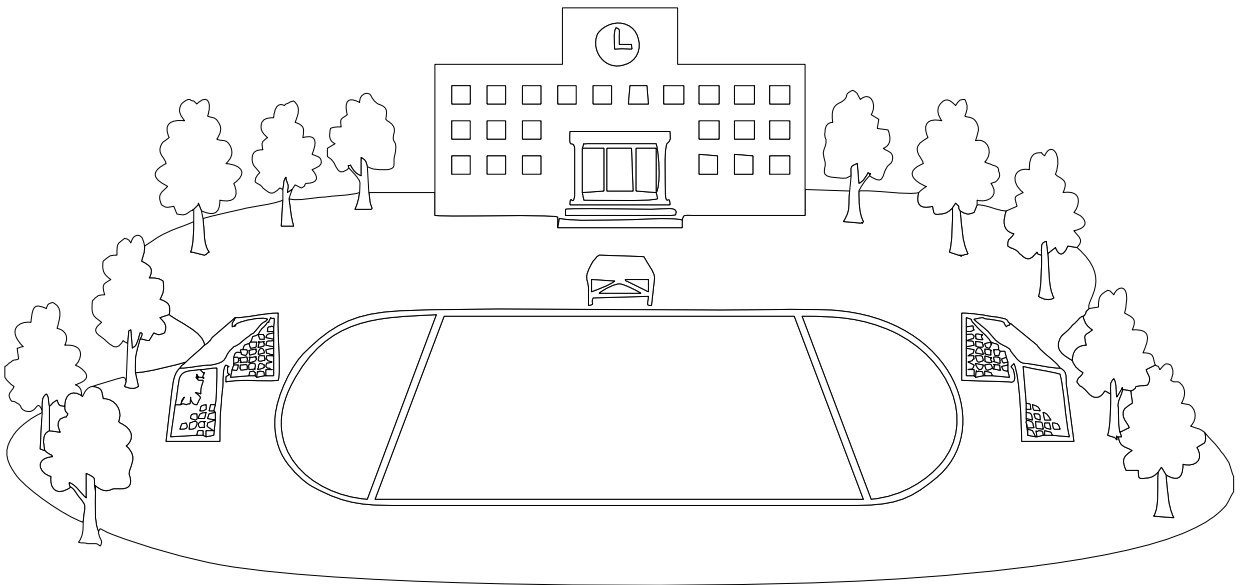

Playground